

# 20\_ITIJ\_Internas-Coauthor-Vol.1No.2-Mei2024-Enterprise Resource Planning (ERP) Design Using TOGAF ADM .pdf

 D.K.T.E. Society's Textile and Engineering Institute, Ichalkaranji

---

## Document Details

Submission ID

trn:oid:::3117:507366983

Submission Date

Oct 3, 2025, 8:05 PM GMT+7

Download Date

Oct 3, 2025, 8:07 PM GMT+7

File Name

20\_ITIJ\_Internas-Coauthor-Vol.1No.2-Mei2024-Enterprise Resource Planning (ERP) Design Using T....pdf

File Size

799.8 KB

14 Pages

4,736 Words

27,462 Characters

# 11% Overall Similarity

The combined total of all matches, including overlapping sources, for each database.





## Filtered from the Report

- ▶ Bibliography
- ▶ Quoted Text
- ▶ Cited Text
- ▶ Abstract
- ▶ Methods and Materials



## Exclusions

- ▶ 1 Excluded Source

## Match Groups

-  **51 Not Cited or Quoted** 11%  
Matches with neither in-text citation nor quotation marks
-  **0 Missing Quotations** 0%  
Matches that are still very similar to source material
-  **0 Missing Citation** 0%  
Matches that have quotation marks, but no in-text citation
-  **0 Cited and Quoted** 0%  
Matches with in-text citation present, but no quotation marks

## Top Sources

- 6%  Internet sources
- 8%  Publications
- 0%  Submitted works (Student Papers)

## Integrity Flags

### 1 Integrity Flag for Review

-  **Hidden Text**  
2 suspect characters on 1 page  
Text is altered to blend into the white background of the document.

Our system's algorithms look deeply at a document for any inconsistencies that would set it apart from a normal submission. If we notice something strange, we flag it for you to review.

A Flag is not necessarily an indicator of a problem. However, we'd recommend you focus your attention there for further review.

### Match Groups

- **51 Not Cited or Quoted 11%**  
Matches with neither in-text citation nor quotation marks
- **0 Missing Quotations 0%**  
Matches that are still very similar to source material
- **0 Missing Citation 0%**  
Matches that have quotation marks, but no in-text citation
- **0 Cited and Quoted 0%**  
Matches with in-text citation present, but no quotation marks

### Top Sources

- 6% ■ Internet sources
- 8% ■ Publications
- 0% ■ Submitted works (Student Papers)

### Top Sources

The sources with the highest number of matches within the submission. Overlapping sources will not be displayed.

1	Publication	Megawati Lestari Pasiak, Andi Wahyu Rahardjo Emanuel. "Enterprise Architecture...	3%
2	Publication	Faiz Kautsar, Indra Budi. "Analysis of Success Factors in The Implementation of E...	<1%
3	Internet	www.portal.mot.go.th	<1%
4	Internet	businessdocbox.com	<1%
5	Internet	www.grafiati.com	<1%
6	Internet	ejournal.polbeng.ac.id	<1%
7	Internet	doan.edu.vn	<1%
8	Internet	e-journal.politanisamarinda.ac.id	<1%
9	Internet	journal.lontaradigitech.com	<1%
10	Internet	kc.umn.ac.id	<1%

11	Internet	repo.unand.ac.id	<1%
12	Publication	George Koliadis. "Relating Business Process Models to Goal-Oriented Requiremen..."	<1%
13	Publication	Maila D.H. Rahiem. "Towards Resilient Societies: The Synergy of Religion, Educati..."	<1%
14	Internet	media.neliti.com	<1%
15	Publication	Alfa Dwi Wahyuningrum, Sunarto Sunarto. "PENGARUH LIKUIDITAS, PROFITABILI..."	<1%
16	Publication	Djaja Amanda, Djarot Hindarto, Eko Indrajit, Erick Dazki. "Proposed use of TOGAF..."	<1%
17	Publication	Hery Dian Septama, Muhamad Komarudin, Puput Budi Wintoro, Mahendra Prata...	<1%
18	Internet	sibresearch.org	<1%
19	Internet	www.aasmr.org	<1%
20	Publication	"Domain-Specific Conceptual Modeling", Springer Science and Business Media LL...	<1%
21	Publication	Gyan Prakash, Amandeep Kaur. "AI and Sustainable Transformations", CRC Press,...	<1%
22	Internet	www.coursehero.com	<1%
23	Internet	www.ijitee.org	<1%
24	Publication	Bachoo, Avsharn. "The Influence of Enterprise Architecture Maturity on Business ..."	<1%

25

Publication

Steve Sentosa, Richardus Eko Indrajit, Erick Dazki. "Enterprise Architecture of the ... <1%

# Enterprise Resource Planning (ERP) Design Using TOGAF ADM and ACMM (Case Study: PT XYZ)

Triyanto <sup>a,1,\*</sup>, Aji Supriyanto <sup>b,2</sup>

<sup>a</sup>Teknologi Informasi Universitas Stikubank Semarang Jl. Tri Lomba Juang 1 Semarang, Indonesia  
<sup>1</sup>triyanto0009@mhs.unisbank.ac.id \*; <sup>2</sup>ajisup@edu.unisbank.ac.id

## ARTICLE INFO

## ABSTRACT

**Keywords**  
ERP  
Unite  
TOGAF ADM  
ACMM  
business process

Enterprise Resource Planning (ERP) is software used by companies to unite and manage information from various parts of the company, or a tool that integrates all aspects of business in a company. However, in order to support the operations of PT XYZ, it has not implemented an Information System in its business activities. In order to support the smooth running of business processes at PT XYZ, it is necessary to design a structured Information System with good planning using the TOGAF ADM framework. Before starting the design, the researcher evaluated the maturity level of PT XYZ by comparing the current condition with the desired one using the Architecture Capability Maturity Model (ACMM). The results of this evaluation were recommendations for an ERP architecture that was adapted to PT XYZ's business processes, including business architecture, data, applications, and technology that have reached their respective level 3 maturity levels.

This is an open access article under the [CC-BY-NC-ND](#) license.



## 1. Introduction

In the era of globalization, companies face increasingly fierce competition and increasing market demands. Efficient business management and responsiveness to market changes is the key to company success amidst current economic dynamics. In an effort to increase efficiency, minimize operational costs, and respond quickly to market changes, companies are looking for integrated and structured information technology solutions. One of the most well-known and widely implemented solutions is Enterprise Resource Planning (ERP). ERP systems provide extensive benefits and facilities for organizations in transferring data information [1]. One framework for implementing ERP is to adopt a company architecture using the Open Group Architecture Framework (TOGAF)[2], while another reference [3] states that the Architecture Capability Maturity Model (ACMM) method is used to measure the maturity of Information Technology architecture (IT). Based on these reasons, this research will implement an information technology plan that will be used by PT. XYZ, with reference to the TOGAF standard. In addition, maturity analysis will also be carried out using the ACMM model developed by the US Department of Commerce (DoC) for IT Architecture.[4].

This research aims to provide recommendations for managing information technology at PT XYZ. These recommendations will provide direction for companies to achieve the current architectural state and the desired architectural direction. It involves business architecture, data, applications, and technology that are expected to reach their respective level 3 maturity levels.



In other research, TOGAF was applied in designing a business framework for the shoe industry sector in Indonesia, with a focus on efforts to increase the competitiveness of the industry [5] and ACMM was used to assess the performance of Information Systems used in marketing the tourism industry [4]. Another study using the ACMM and TOGAF methods produced an architectural plan that can be a guide in improving the role of information systems and technology [6]. So the difference between this research and this research is the use of mixed research methods (mixed methods) TOGAF to formulate ERP architecture designs and ACMM to measure the maturity level of Information Technology (IT) architecture.

Based on the explanation above, the problems and literature review are used as research material under the title "Enterprise Resource Planning (ERP) Maturity Level Planning Using ACMM and TOGAF ADM at PT XYZ"

The role of Enterprise Architecture is in adapting and developing ERP systems in line with changing business needs, thereby enabling organizations to overcome challenges and proactively utilize new technology [7]. Implementing an ERP system has the potential to enable a company to better manage its business with potential benefits in the form of improved process flow, better data analysis, higher quality data for decision making, reduced inventory, improved coordination across the supply chain, and better customer service [8]. In developing an IT strategy, one option when developing an IT strategy is to utilize Enterprise Architecture [9]. After analysis by TOGAF ADM, researchers provided recommendations for application development [10]. In solving problems, the method used involves the application of the TOGAF ADM framework, which is based on a literature review of previous studies [11]. To support the smooth running of business processes, it is important to design Information Systems with structured planning. This aims to prevent failures and problems during the implementation of Information Systems [12].

TOGAF ADM is a very complete methodological approach. Each phase in this method results in the development of an integrated enterprise architecture. This architecture acts as a detailed guide for companies, providing a blueprint that helps them achieve their stated strategic goals [13]. Continuous connectivity between various fields is crucial so that business processes run according to predetermined expectations [14]. TOGAF ADM includes a series of steps including the Preliminary Phase, Vision Architecture, Business, Technology Information Systems, Opportunities and Challenges, and Migration Plan as part of the planning process that produces an architectural blueprint. This blueprint was prepared by referring to the TOGAF ADM framework [15], [16].

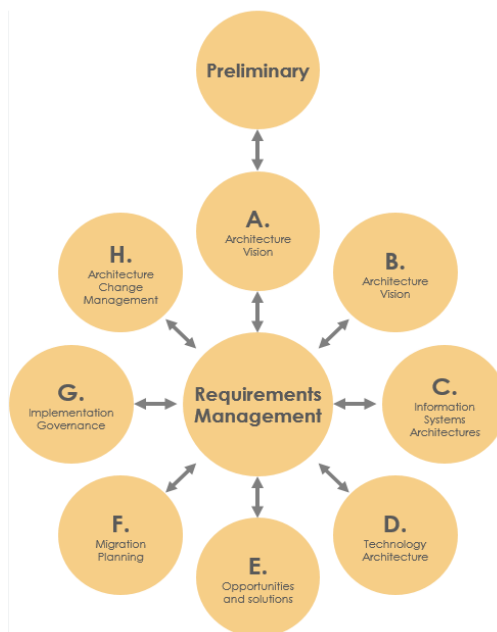

Figure 1 TOGAF ADM cycle source [16]

ACMM provides a structure that represents crucial elements in the formation of an efficient enterprise architecture process. The primary goal is to increase the chances of overall enterprise

architecture success by identifying weaknesses and providing detailed development plans to improve the overall architecture process. Capability Maturity Model (CMM) is a maturity framework that supports defining and understanding processes within an organization [17]. The ACMM framework has six maturity levels and nine architectural elements. The six levels include: Existent, Initial, Repeatable, Define, Manage, and Optimized. [18]. The nine components of the Company's architecture include: 1 - Architectural Planning, 2 - Architectural Development, 3 - Business Relations, 4 - Senior Management Participation, 5 - Involved Unit Operations, 6 - Architectural Communication Structure, 7 - Information Technology Security, 8 - Architecture Governance, 9 - Information Technology Investment and Acquisition Strategy [19].

Business Process Modeling Notation (BPMN) is an innovative approach developed by the Business Process Modeling Initiative as the newest standard in business process modeling. BPMN also acts as a design tool for complex systems such as e-business systems that use message bases.

This research aims to provide recommendations for managing information technology at PT XYZ. These recommendations will provide direction for companies to achieve the current architectural state and the desired architectural direction. It involves business architecture, data, applications, and technology that are expected to reach their respective level 3 maturity levels.

## 2. Method

In this method stage, the methods, steps and framework used in this research will be explained. This research adopts an approach that combines qualitative and quantitative methods. Quantitative methods are applied to collect data in the form of numbers and measure the maturity level of IT architecture using ACMM. Qualitative methods are used to gain an in-depth understanding of business processes. Data collection uses two main methods: interviews and observation. This research framework adopts the fundamental structure of TOGAF ADM, which consists of the following work cycle:

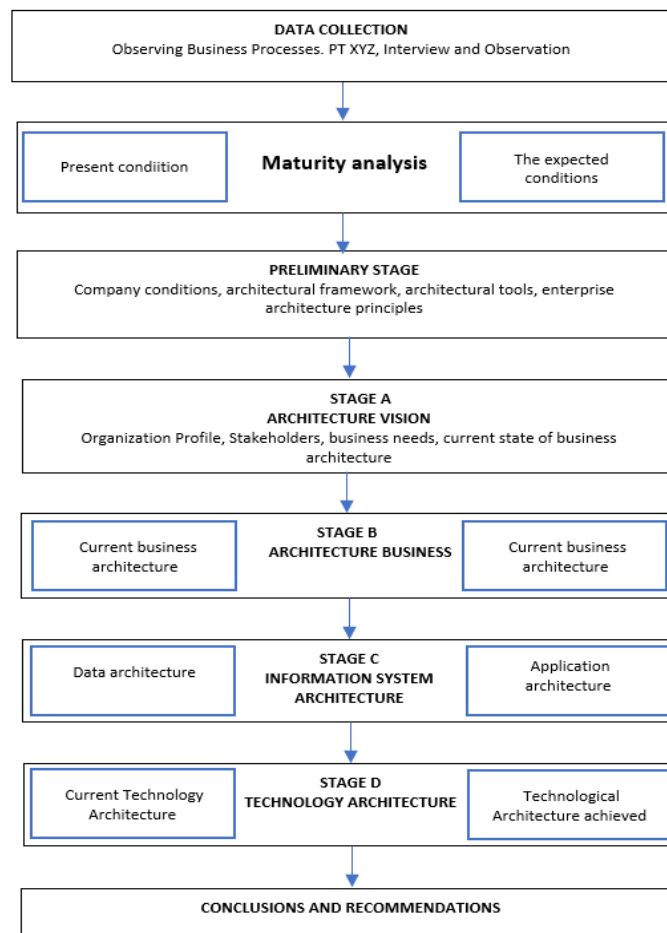

Figure 2 Research Methods



## 2.1. Data Collection

Researchers begin the data collection process by observing the running of business processes within the organization. Apart from observations, the author also conducted interviews with stakeholders who have key roles and in-depth understanding of the company's business processes. The first step is to identify all current weaknesses. Table 1 provides an overview of the interrelationships between the four core components of enterprise architecture and an evaluation of nine architectural characteristics.

Table 1 Architectural Component Assessment

Characteristic Architecture	Architecture Business	Architecture Data	Architecture Applications	Architecture Technology
1 Architectural Planning	✓			
2 Architectural Development	✓	✓	✓	✓
3 Business relationship	✓			
4 Senior Management Participation		✓	✓	✓
5 Operations of Units Involved	✓	✓	✓	✓
6 Architectural Communication Structure		✓		✓
7 Information Technology Security				✓
8 Government Architecture	✓	✓	✓	✓
9 Information Technology Investment and Acquisition Strategy	✓	✓	✓	✓

## 2.2. Maturity analysis

Evaluate the use of information technology at PT. XYZ aims to identify differences between existing conditions and the desired ideal conditions. This evaluation covers aspects of business architecture, data, applications and technology, with a maturity level target of level 3 for each.

## 2.3. Preliminary

Action steps are prepared and initiated to meet business guidelines related to the development of the new enterprise architecture. Part of this process includes determining the specifics of the organizational architectural framework and formulating the necessary principles.

## 2.4. Architecture vision

Identification of the need to design an information system occurs, such as defining the organization's vision, mission, goals, and business processes. The input obtained includes architecture creation requests and enterprise architecture principles. The outcome includes approval of the architectural work, including scope, boundaries, and architectural implementation plans and architectural principles, including business principles and architectural vision.

## 2.5. Business Architecture

This step represents the beginning of the process of designing a business architecture. The next step is to determine the desired business activity model to be achieved, which is based on the business scenario and analysis that has been carried out, especially in terms of the organization's business processes, especially in the sales and purchasing sections.

The purpose of this stage is to understand the activities carried out by the organization in managing the company's business processes. With the understanding gained about business processes, the information can be used as a basis for designing new systems, as well as assisting in selecting appropriate and appropriate techniques and tools.

## 2.6. Data architecture

Data architecture emphasizes the use of data to meet business functional requirements, processes, and services. At this stage, the entities of the data are identified based on the available business structure, while the flow of information between systems is also analyzed as data entities. However, this architecture is not included in database design. The focus is on defining data entities that are important to the enterprise, not planning physical and logical storage systems.

## 2.7. Application architecture

Core application systems that are vital in processing data and supporting business operations will be identified. However, this application architecture is not involved in the application system design process. The goal is to identify the types of application systems that are important to the company and determine which applications are needed to manage data and present information to human users and computers in the company.

## 2.8. Technology architecture

This step begins by identifying the technology needed to design the desired technology architecture, compiled using a technology portfolio catalog which includes software and hardware. Apart from that, this stage also considers the options needed in the process of selecting appropriate technology.

## 2.9. Expected Architecture Evaluation Results

This stage is the result of evaluating the level of maturity after the proposal is made. So that after the proposal is made for each architecture, the difference between the current condition and the condition after the architectural proposal is made can be seen.

## 3. Results and Discussion

Evaluating the company's current architecture, researchers apply analysis at each stage using Analysis using data collection and interviews to understand the actual conditions and achievement of each strategic measure and goal. The evaluation results are then grouped into nine architectural characteristics that are in accordance with the architectural direction at the ADM TOGAF stage. The evaluation is carried out on the calculation output for each target and strategic indicators in each architectural characteristic.

### 3.1. Current Architecture Evaluation Results

Below are the results of an assessment of the current architecture. The assessment was carried out using the Enterprise Architecture Capability Maturity Model (ACMM). Based on the level of maturity of each architectural characteristic, calculations are carried out using 2 methods, namely:

The first method is to calculate the maturity level of architectural capabilities in the operating unit.

Table 2: Current calculations from ACMM Method 1 Architecture

Characteristic Architecture	Achieved characteristics			
	Architecture Business	Architecture Data	Architecture Applications	Architecture Technology
1. Architectural Planning	2	-	-	-
2. Architectural Development	2	1	1	2
3. Business relationship	1	-	-	-
4. Senior Management Participation	-	1	1	1
5. Operations of Units Involved	$(4+4) / 2$	$(2+3)/2$	$(2+3)/2$	$(3+4)/2$
6. Architectural Communication Structure	-	$(0+2+1) / 3$	-	$(3+1+1)/3$
7. Information Technology Security	-	-	-	0

8.	Government Architecture	1	2	0	2
9.	Information Technology Investment and Acquisition Strategy	1	3	1	1
<b>Total</b>		<b>11</b>	<b>10,5</b>	<b>5,5</b>	<b>11,2</b>
<b>Total Score / Total Characteristics</b>		<b>1,83</b>	<b>1,75</b>	<b>1,1</b>	<b>1,6</b>

Business architecture has a score of 1.83, data architecture has a score of 1.75, application architecture has a score of 1.1, and technology architecture has a score of 1.6. The score is obtained from the total number of maturity levels for each architectural characteristic divided by the number of maturity levels.

The second method involves depicting the percentage of achievement for each maturity level of nine architectural characteristics.

Table 3: Current calculations from ACMM Method 2

Maturity Level	Architecture Business		Architecture Data		Architecture Applications		Architecture Technology	
	Appearance at each level	%	Appearance at each level	%	Appearance at each level	%	Appearance at each level	%
0	1	0,0%	0	0,0%	1	20,0%	1	14,29%
1	3	50,0%	3	50,0%	3	60,0%	2	28,57%
2	2	33,33%	1	16,67%	0	0,00%	3	42,86%
3	0	0,00%	2	33,33%	1	20,00%	1	14,29%
4	1	16,67%	0	0,00%	0	0,00%	0	0,00%
5	0	0,00%	0	0,00%	0	0,00%	0	0,00%
Total		100%		100%		100%		100%

### 3.2. Expected architectural design

Develop an information system architectural model for Enterprise Resource Planning (ERP), using an approach that follows TOGAF and takes attention to Business Architecture, Data, Applications and Technology. With the aim of increasing the level of architectural maturity to reach level 3 using ACMM.

### 3.3. Preliminary phase

The first step in preparing the Enterprise Resource Planning (ERP) design. At this stage, it will be decided how Enterprise Resource Planning (ERP) will be developed and implemented by stakeholders to support PT's business process activities. XYZ. The following are the principles applied in designing Enterprise Architecture for business processes PT. XYZ, which is described in Table 4 below:

Table 4 Preliminary Phase

NO.	PRINCIPLE	OBJECTIVE
1	ERP architecture decisions taken by stakeholders must be in line with the objectives of	<ul style="list-style-type: none"> <li>Support Purchase management business processes.</li> <li>Support sales management business processes</li> </ul>

	designing the PT's business process activity flow. XYZ.	<ul style="list-style-type: none"> <li>Supports Inventory and Delivery business processes. Management.</li> <li>Support Financial Management business processes.</li> </ul>
2	The architecture that will be created must have continuity with PT's business processes. XYZ.	Prevent misunderstandings with other business processes, so as not to hamper PT business process activities. XYZ.
3	Development of an integrated ERP application for business process monitoring activities.	<ul style="list-style-type: none"> <li>Presents sales monitoring information to increase revenue.</li> <li>Makes it easier to process data into more accurate and efficient information.</li> </ul>
4	Creating a user friendly system, to make it easier for users to use the application.	<ul style="list-style-type: none"> <li>A system that is easy for users to use from the input process to the output process in the system.</li> <li>Make it easier for stakeholders to manage the flow/process of business process activities.</li> </ul>
5	Information can be easily accessed by users.	<ul style="list-style-type: none"> <li>Makes it easier to present sales status information.</li> <li>Speed up decision making if problems occur related to sales activities.</li> </ul>

16

This section discusses the results of the research and at the same time also provides a comprehensive discussion. Research results can be presented using pictures, graphs, tables, and others that enable readers to understand the research results easily. Discussion can be made using several sub-chapters.

### 3.4. Architecture Vision

Realizing the requirements needed to develop an ERP information system architecture, including organizational profile, vision and mission, strategy, and objectives, along with organizational targets, as well as identifying stakeholders and related business needs.

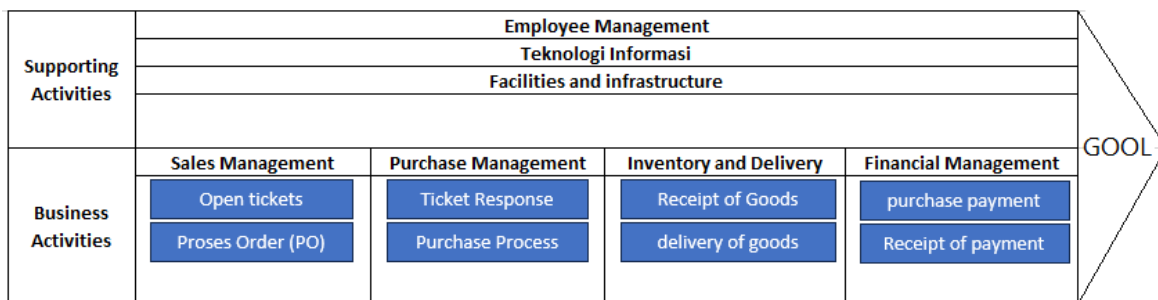

Figure 3. Value Chain

### 3.5. Current Business Architecture

The current Sales Management architecture business process is depicted through BPMN as in Figure 4

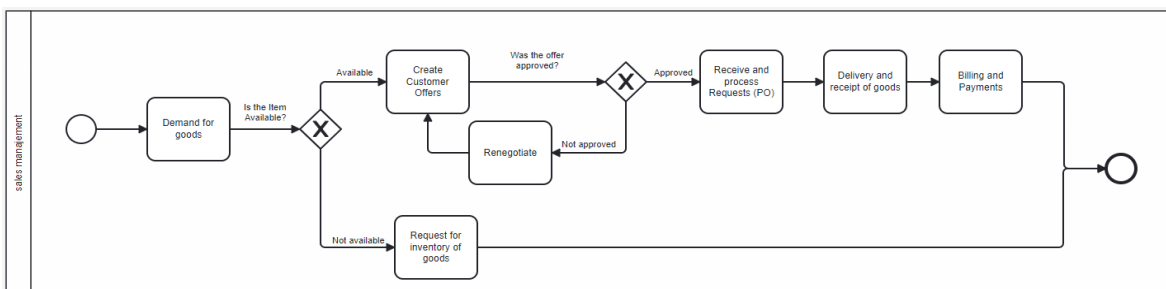

Figure 4. Current Sales Management Business Process

The current Purchase Management architecture business process is depicted through BPMN as in Figure 5

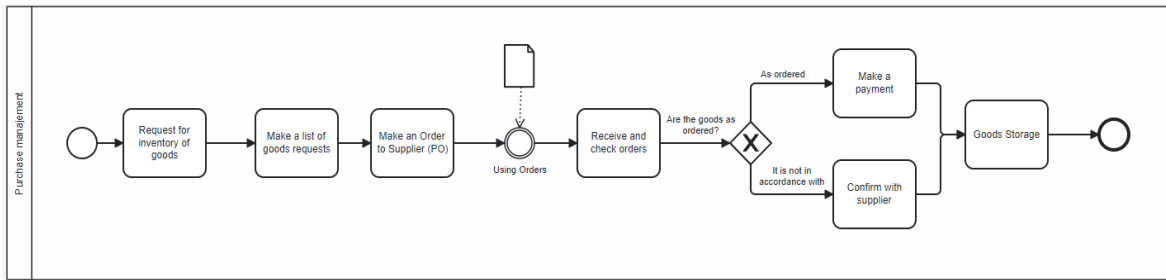

Figure 5. Current Purchase Management Business Process

The current Inventory and Delivery management architecture business process is depicted through BPMN as in Figure 6

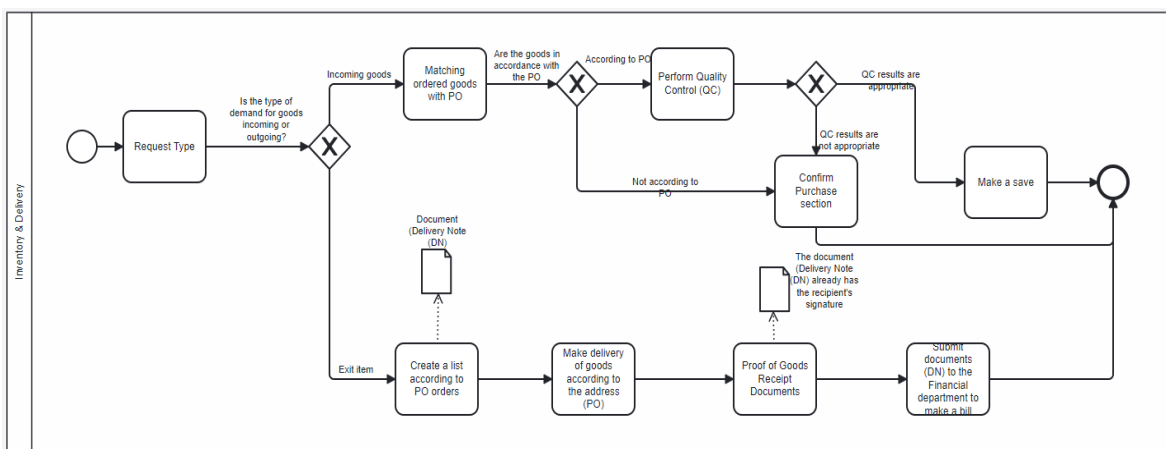

Figure 6. Current Inventory and Delivery Business Process

The current Financial Management architecture business process is depicted through BPMN as in Figure 7

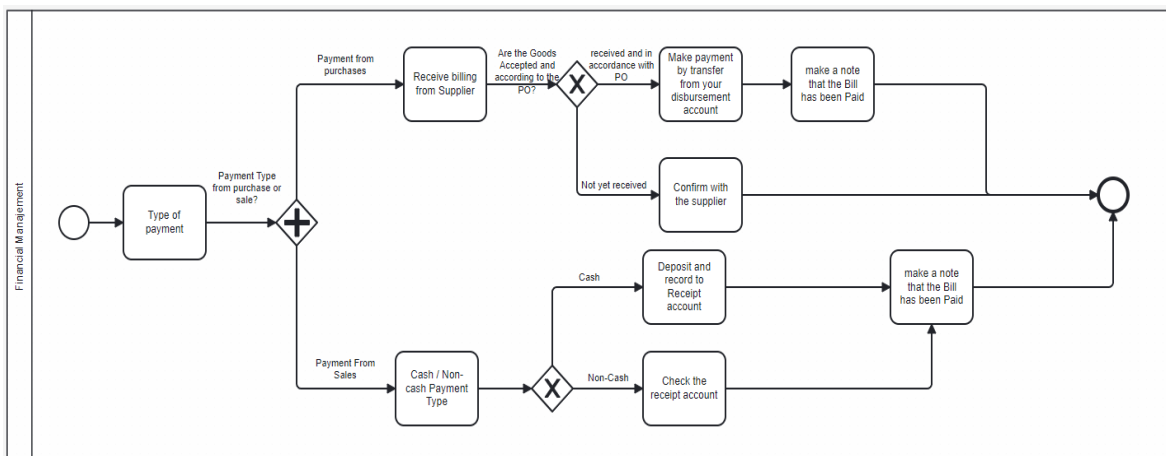

Figure 7. Current Financial Management Business Process

### 3.6. Proposed Business Architecture

The proposed ERP architecture business process is depicted through BPMN as in Figure 8

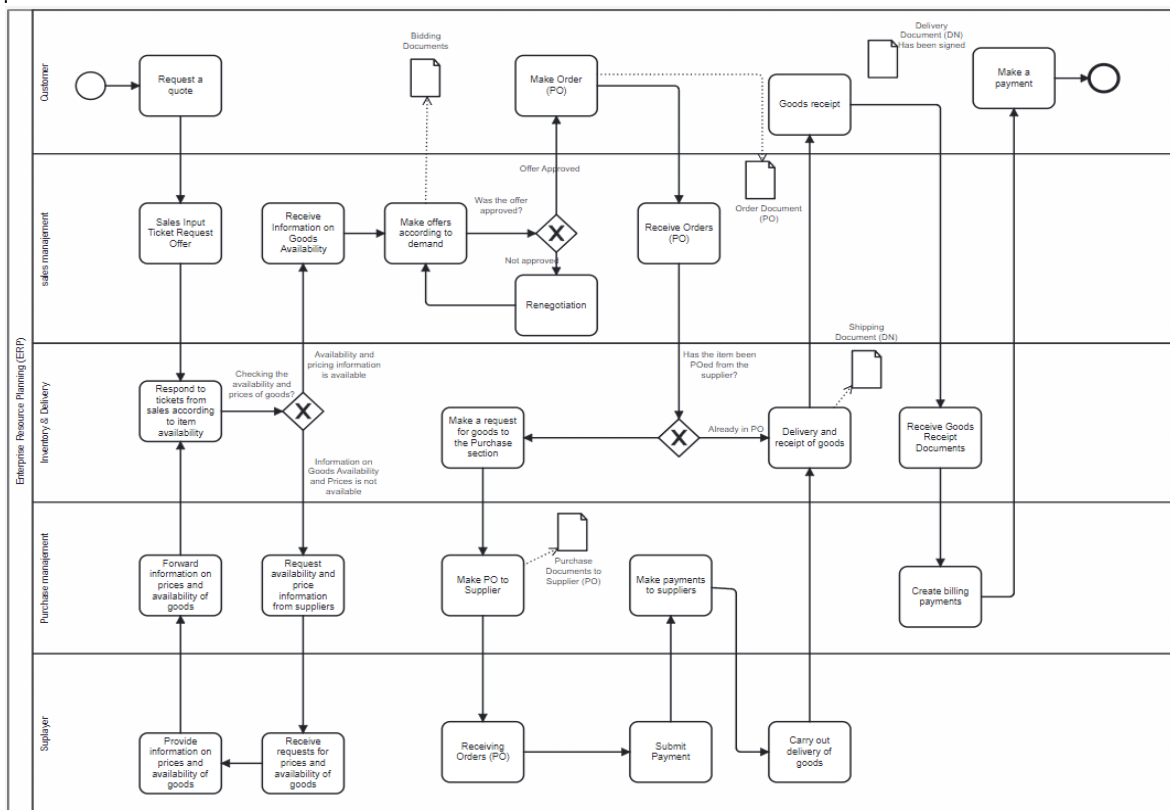

Figure 8. Proposed ERP Business Process

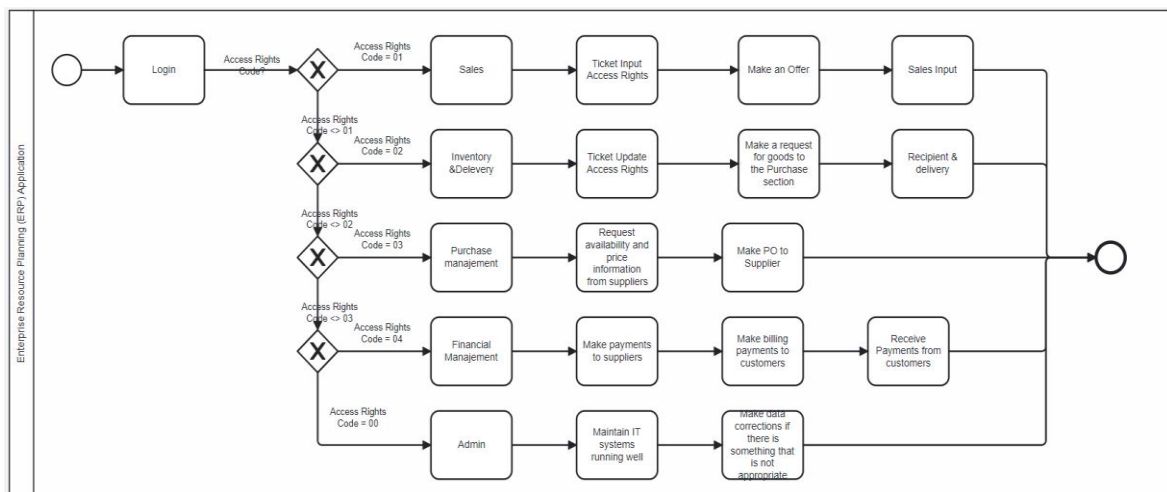

Figure 9. Proposed ERP Business Process Access Rights

### 3.7. Data architecture

Designing and building systems for companies aims to manage all important data. The interview and observation process is used to identify important information related to business operations. The results of interviews and observations show that there are four main activities at the moment: Sales management, Purchase management, Inventory delivery management and Financial management, which involve data or information that is important for the business. There were seven data entities that were identified during the interviews, each with associated data attributes collected through the interview activities. However, the data entities and attributes can be seen in table 5.

Table 5. Data architecture

Activities	Entities	Attributes
------------	----------	------------

	Sales	id_sales,nama_sales,no_telp
	Pelanggan	id_pelanggan,nama_pelanggan,alamat,no_telp
	Produk	id_produk,nama_produk,Spesifikasi,harga_jual
Sales Manajement	Trx_tiket_permintaan	id_tiket,id_sales,id_pelanggan,tgl_tiket,id_produk,jumlah,status_tiket
	trx_penawaran	id_penawaran,id_pelanggan,tgl_penawaran,id_produk,sts_penawaran
	trx_penjualan	id_tiket,id_sales,id_pelanggan,tgl_penjualan,id_produk,jumlah,status_penjualan
Inventory dan Delivery	Stock_barang	id_produk,jumlah_stock,harga_modal,harga_jual
	trx_permintaan	id_tiket,id_sales,jumlah_permintaan
	trx_pengiriman	id_penjualan,id_pelanggan,alamat_pengiriman,tgl_pengiriman,jumlah_barang
Purchase manajement	trx_penpembelian	id_order,id_suplayer,tgl_pemesanan,tgl_pengiriman,id_barang,jumlah_barang,harga_beli,sts_order
	Suplayer	id_suplayer,alamat_suplayer,pic_suplayer,no_telp
Financial Manajement	trx_penjualan	id_penjualan,tgl_penagihan,jatuh_tempo,jumlah_pembayaran,sts_penjualan
	trx_pembelian	id_pembelian,tgl_penagihan,jatuh_tempo,jumlah_pembayaran,sts_penjualan

### 3.8. Application architecture

The results of interviews and observations show that there are several activities with entities that can be supported by implementing the system. There are four applications that can help use a system or application, namely Sales Management, Inventory Delivery, Purchase Management and Financial Management. Each application has a function that can accommodate business operational activities. The architecture of the application or system can be seen in table 6.

Table 6. Application Architecture

Application	Application Functions	System Identification
Sales Manajement	The application functions to record and recap every transaction that occurs in the sales process, starting from the request process from customers to sales	Enterprise Resource Planning (ERP)
Inventory dan Delivery	This application functions to check product availability and product delivery to customers. If the product is not available, it will automatically send a request form to the Purchase Department to place an order with the supplier	

Purchase manajemnt	This application functions to carry out the purchasing process from suppliers
Financial Manajemnt	This application functions to carry out the billing process to customers and payments to suppliers

**3.9. Technology architecture**

Technology architecture, especially the role of hardware and networks applied to the ERP system at PT. XYZ consists of 1 colocation server on a third party connected to the public internet, 5 client PCs, 5 printers, 5 labtops, one switch, and one router. 5 PC clients located at the office.

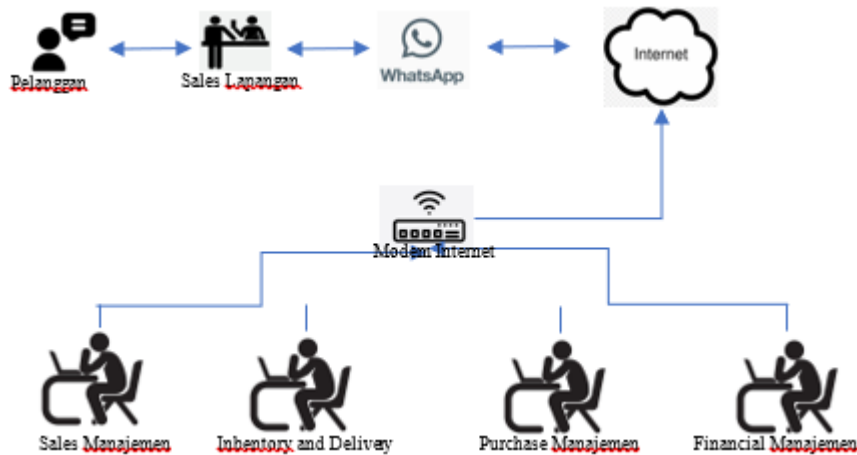

Figure 10. Current technology architecture

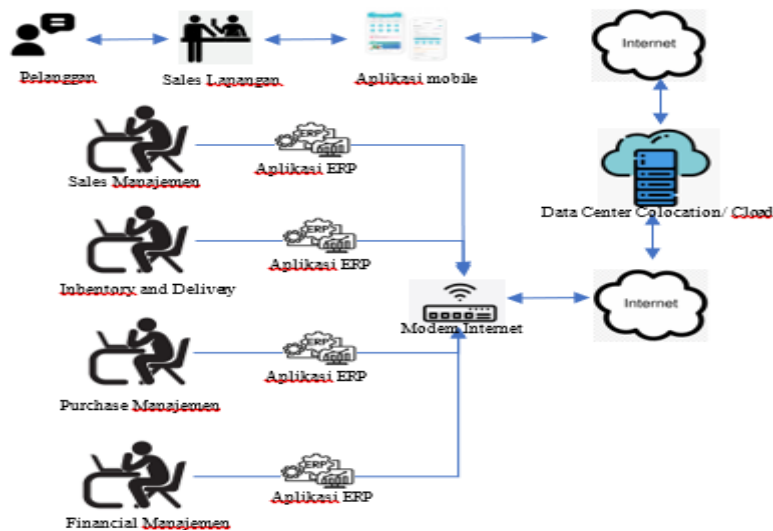

Figure 11. Proposed technology architecture

**3.10. Expected Architectural Evaluation Results**

Below are the expected assessment results for Architecture. The evaluation was carried out using the Enterprise Architecture Capability Maturity Model (ACMM). Based on the level of maturity for each architectural characteristic, calculations are carried out using 2 methods, namely:

The first method calculates the maturity level of Architectural Capabilities in Operational Units.

Table 7 Method 1 Expected calculations for the ACMM Architecture



Characteristic Architecture	Achieved characteristics			
	Architecture Business	Architecture Data	Architecture Applications	Architecture Technology
1. Architectural Planning	4	-	-	-
2. Architectural Development	3	3	5	3
3. Business relationship	3	-	-	-
4. Senior Management Participation	-	3	2	2
5. Operations of Units Involved	$(4 + 4) / 2$	$(3 + 3) / 2$	$(3 + 2) / 2$	$(4 + 3) / 2$
6. Architectural Communication Structure	-	$(2 + 3 + 3) / 3$	-	$(1 + 1 + 3) / 3$
7. Information Technology Security	-	-	-	4
8. Government Architecture	2	3	3	5
9. Information Technology Investment and Acquisition Strategy	3	3	3	3
<b>Total</b>	<b>19</b>	<b>17,7</b>	<b>16,5</b>	<b>22,5</b>
<b>Total Score / Total Characteristics</b>	<b>3,17</b>	<b>2,95</b>	<b>3,81</b>	<b>3,26</b>

Testing with method 1 shows that the Maturity Level of Architectural Capabilities in Operational Units for each characteristic is:

Architecture Business achieved a score of 3.17, Architectural Data achieved a score of 2.95, Architectural Applications achieved a score of 3.20, and Architectural Technology achieved a score of 3.30.

The second method displays the percentage of achievement at each level for the nine architectural characteristics.

Table 8 Method 2 Expected Calculations for ACMM

Maturity Level	Architecture Business		Architecture Data		Architecture Applications		Architecture Technology	
	Appearance at each level	%	Appearance at each level	%	Appearance at each level	%	Appearance at each level	%
0	0	0,00%	0	0,00%	0	0,00%	1	0,00%
1	0	0,00%	0	0,00%	0	0,00%	0	0,00%
2	1	16,67%	0	0,00%	1	20,00%	1	14,29%
3	3	50,00%	6	100,0%	2	40,00%	4	57,14%
4	2	33,33%	0	0,00%	1	20,00%	1	14,29%
5	0	0,00%	0	0,00%	1	20,00%	1	14,29%
Total		100%		100%		100%		100%

#### 4. Conclusion

Based on the research and analysis results obtained, it can be concluded that TOGAF ADM is used as a comprehensive information architecture planning tool, while ACMM functions as an evaluation method or measurement of the level of maturity in the use of information technology. The guide provided by TOGAF includes details on Business, Data, Application and Technology architecture. All types of architecture are integrated as part of a process in an architectural framework.

Testing using the Enterprise Architecture Capability Maturity Model (ACMM) before making the Architecture Business proposal showed a score of 1.83, Architecture Data 1.75, Architecture Application 1.1, and Architecture Technology 1.6. After making a proposal on Enterprise Architecture, the score increased to Architecture Business 3.17, Architecture Data 2.95, Architecture Application 3.20, and Architecture Technology 3.30. From the entire writing process, it can be concluded that designing information system architecture can make an effective contribution to PT. XYZ to carry out its business operations more efficiently by integrating the systems proposed to be built and increasing the maturity level of the Technology Architecture to reach level 3.

#### References

- [1] Serumena, D. R., Lena, P. H., & Robo, S. (2019). Identifikasi Manajemen Resiko yang diusulkan pada Operasional SME dalam Penerapan Sistem ERP Jangka Panjang . Jurnal RESTI (Rekayasa Sistem dan Teknologi Informasi), 3(1), 50-58.
- [2] Guntara, A., Saeppani, A., Fadil, I., & Supriadi, F. (2020, October). Enterprise Information System Planning Using TOGAF Architecture Development Method on XYZ College. In 2020 8th International Conference on Cyber and IT Service Management (CITSM) (pp. 1-6). IEEE.
- [3] Retnasari, T., & Prihatin, T. (2020). Evaluasi Sistem Informasi Cibugary Dalam Peningkatan Promosi Eduwisata Dengan Architecture Capability Maturity Model Score. INOVTEK Polbeng-Seri Informatika, 5(2), 250-262.
- [4] Meyer, M., Helfert, M., & O'Brien, C. (2011). An analysis of enterprise architecture maturity frameworks. In Perspectives in Business Informatics Research: 10th International Conference, BIR 2011, Riga, Latvia, October 6-8, 2011. Proceedings 10 (pp. 167-177). Springer Berlin Heidelberg.
- [5] Firnaldo, F., Sholihah, U., & Yunita, S. (2023). Perancangan Enterprise Architecture Pada PT. Trisatya Cipta Utama menggunakan TOGAF. JIPI (Jurnal Ilmiah Penelitian dan Pembelajaran Informatika), 8(3), 959-970.
- [6] Dazki, E., & Indrajit, R. E. (2023). Enterprise Architecture With TOGAF In The Indonesian Footwear Industry, Case Study At XYZ Footwear Industry. Jurnal Teknik Informatika (Jutif), 4(6), 1495-1506.
- [7] Wedha, B. Y., & Hindarto, D. (2023). Maximizing ERP Benefits with Enterprise Architecture: A Holistic Approach. Journal of Computer Networks, Architecture and High Performance Computing, 5(2), 703-713.
- [8] Hermanto, A., Mandita, F., & Supangat, S.(2020). Perencanaan Peningkatan Kematangan Teknologi Informasi Menggunakan ACMM dan TOGAF pada Politeknik XYZ.
- [9] Budianto, F. A., Fauzi, R., & Santosa, I. (2022). Perancangan Enterprise Architecture Dengan TOGAF ADM 9.2 Pada Fungsi Business Planning and Performance Pada PT XYZ. Jurnal Ilmiah Teknologi Informasi Asia, 16(2), 75-84.
- [10] Renanda, D. A., & Nerisafitra, P. (2023). Perancangan Enterprise Architecture pada PT Semanggi Mas Sejahtera Menggunakan TOGAF. Journal of Emerging Information System and Business Intelligence (JEISBI), 4(1), 38-49.
- [11] Rizky, M., Amri, F. B., Rosidah, A., Styaningrum, N. P., & Fitroh, F. (2022). Usulan Perencanaan Enterprise Architecture Aplikasi Flip. id Menggunakan TOGAF ADM. Journal of Computer Science and Engineering (JCSE), 3(1), 28-40.
- [12] Rahman, R. (2023). Perencanaan Enterprise Resource Planning Menggunakan TOGAF Architecture Development Methode Sebagai Salah Satu Strategi Pengembangan Perusahaan

(Studi Kasus di Institut Teknologi Bacharuddin Jusuf Habibie). *Jurnal Ilmiah Sains Teknologi Dan Informasi*, 1(2), 33-49.

- [13] Priatna, A., & Yusuf, A. M. (2020). Pengembangan Integrated System Architecture Dengan Menggunakan Framework Togaf Adm (Studi kasus: PT XWZ). *Jurnal Interkom: Jurnal Publikasi Ilmiah Bidang Teknologi Informasi Dan Komunikasi*, 15(2), 63-71.
- [14] Pangestu, A. A. (2021). Perencanaan Arsitektur Enterprise Menggunakan Togaf Adm Pada Dispora Kota Salatiga. *JATISI (Jurnal Teknik Informatika dan Sistem Informasi)*, 8(2), 826-836.
- [15] Setiawan, M. F., Yasirandi, R., & Anwar, M. (2023). Perancangan Enterprise Architecture Pada Perusahaan Distributor Menggunakan Framework TOGAF ADM (Studi Kasus pada CV. XYZ). *eProceedings of Engineering*, 10(2).
- [16] Amanda, D., Hindarto, D., Indrajit, E., & Dazki, E. (2023). Proposed use of TOGAF-Based Enterprise Architecture in Drinking Water Companies. *Sinkron: jurnal dan penelitian teknik informatika*, 8(3), 1265-1277.
- [17] Proença, D., & Borbinha, J. (2017, July). Enterprise architecture: A maturity model based on TOGAF ADM. In *2017 IEEE 19th conference on business informatics (cbi)* (Vol. 1, pp. 257-266). IEEE.
- [18] Shen, L., Du, X., Cheng, G., & Wei, X. (2021). Capability maturity model (CMM) method for assessing the performance of low-carbon city practice. *Environmental Impact Assessment Review*, 87, 106549.
- [19] Song, H., & Song, Y. T. (2010, August). Enterprise architecture institutionalization and assessment. In *2010 IEEE/ACIS 9th International Conference on Computer and Information Science* (pp. 870-875). IEEE.